

Features

- Single-Turn / Cermet / Industrial / Sealed
- Miniature package
- Rotor designed for automatic machine adjust interface
- Withstands harsh environments and immersion cleaning processes
- RoHS compliant*

Electrical Characteristics

Standard Resistance Range 10 to 5 M
 (see standard resistance table)
 Resistance Tolerance ±10 % std.
 Absolute Minimum Resistance 1 % or 2
 (whichever is greater)
 Contact Resistance Variation 1 % or 3 max.
 (whichever is greater)
 Adjustability
 Voltage ±0.05 %
 Resistance ±0.15 %
 Resolution Infinite
 Insulation Resistance 500 VDC
 1,000 M min.
 Dielectric Strength 600 VAC
 Adjustment Angle 240 ° nom.

Environmental Characteristics

Power Rating (300 volts max.)
 70 °C 0.50 watt
 125 °C 0 watt
 Temperature Range -55 °C to +125 °C
 Temperature Coefficient ±100 PPM/°C
 Shock 100 G (1 % ΔTR; 1 % ΔVR)
 Load Life.. 1,000 hours 0.5 watt @ 70 °C
 (3 % ΔTR; 3 % or 3 ohms, whichever is greater, CRV)
 Rotational Life 200 cycles
 (4 % ΔTR; 3 % or 3 ohms, whichever is greater, CRV)

Physical Characteristics

Mechanical Angle 270 ° nom.
 Torque 3.0 oz-in. max.
 Stop Strength 7.0 oz -in. min.
 Terminals Solderable pins
 Standard Packaging 50 pcs. per tube
 Storage Condition 40 °C max. / 70 % R.H. max.

How To Order

3362 W - 253

Model _____
 Style _____
 Resistance Code _____

Standard Resistance Table

Resistance (Ohms)	Resistance Code
10	100
20	200
50	500
100	101
200	201
500	501
1,000	102
2,000	202
5,000	502
10,000	103
20,000	203
25,000	253
50,000	503
100,000	104
200,000	204
250,000	254
500,000	504
1,000,000	105
2,000,000	205
2,500,000	255
5,000,000	505

3362 – 1/4 " Square Trimming Potentiometer

Product Dimensions

Top Adjust

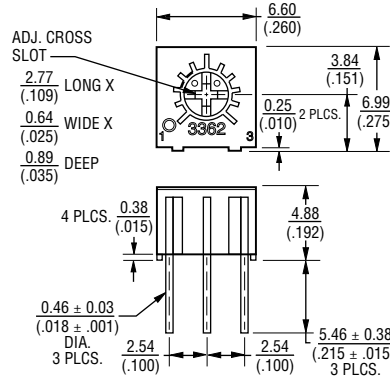

3362F

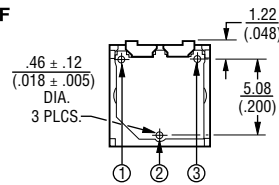

3362H

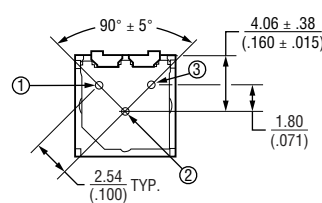

3362P

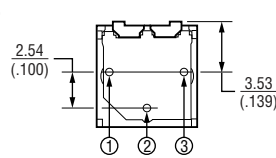

3362R

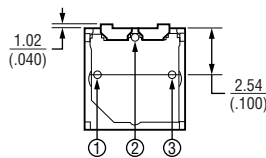

3362U

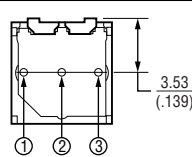

Side Adjust

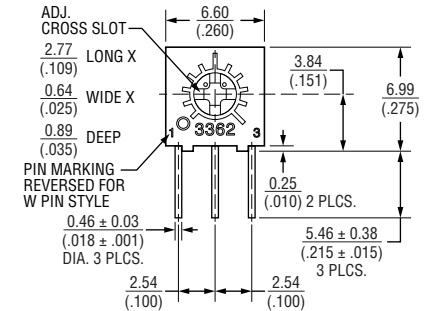

3362M

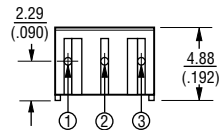

3362S

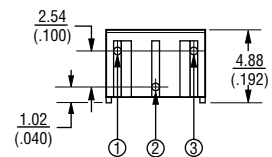

3362W

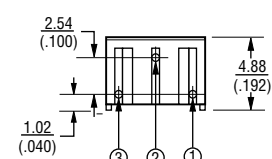

3362X

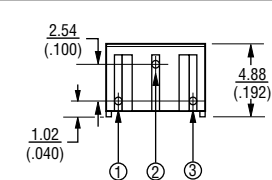

3362Z

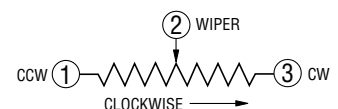
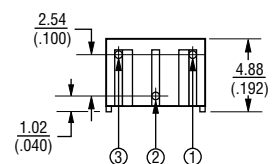

DIMENSIONS: $\frac{\text{MM}}{\text{INCHES}}$

TOLERANCES: ± 0.25 (.010) EXCEPT WHERE NOTED